

CE3201 Lab #3

Interpreting Traffic Data from
Inductance Loop Detectors

ILD Physical Components

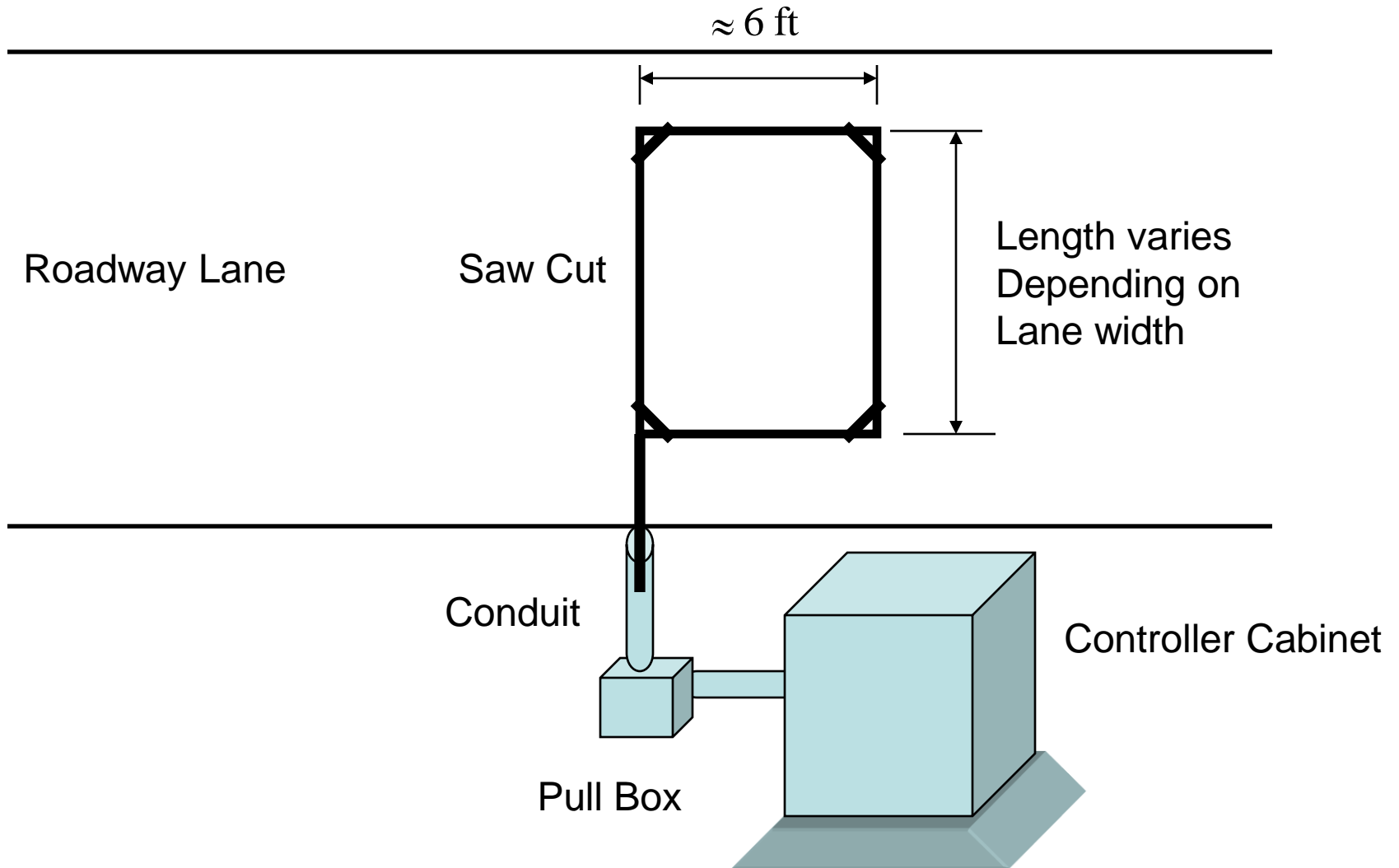

Time $t = t_0$

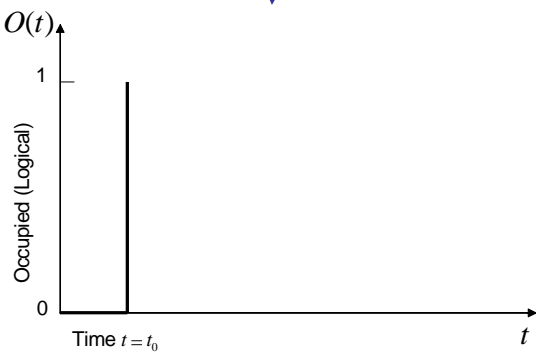
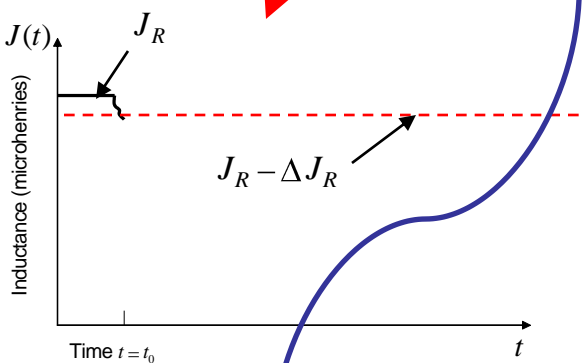
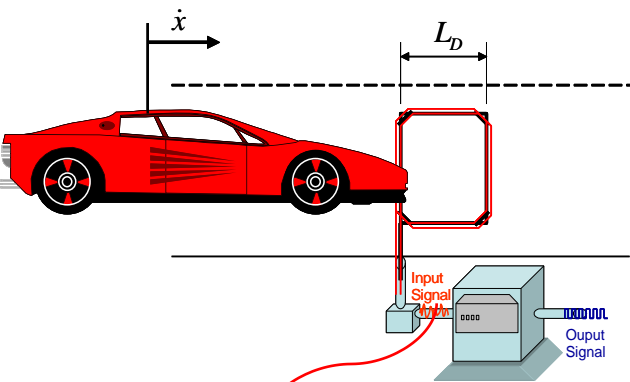

Time $t_0 \leq t \leq t_0 + (L + L_D)/\dot{x}$

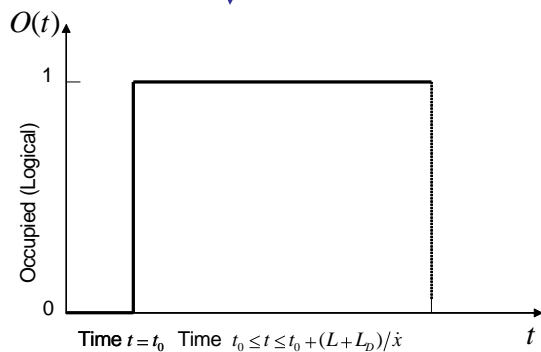
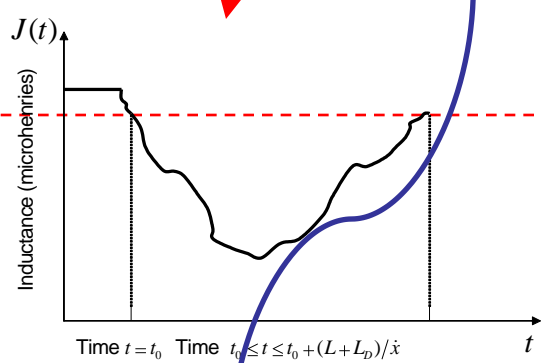
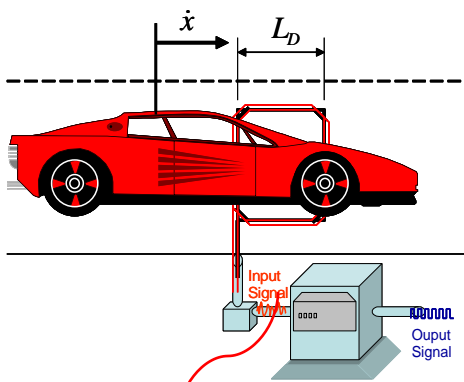

Time $t = t_0 + (L + L_D)/\dot{x}$

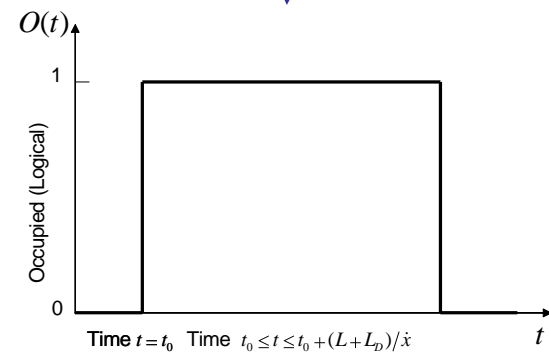
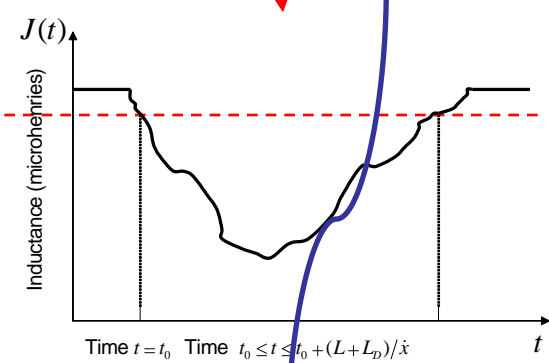
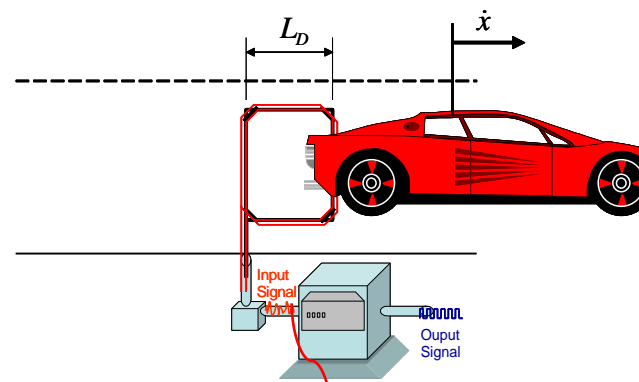

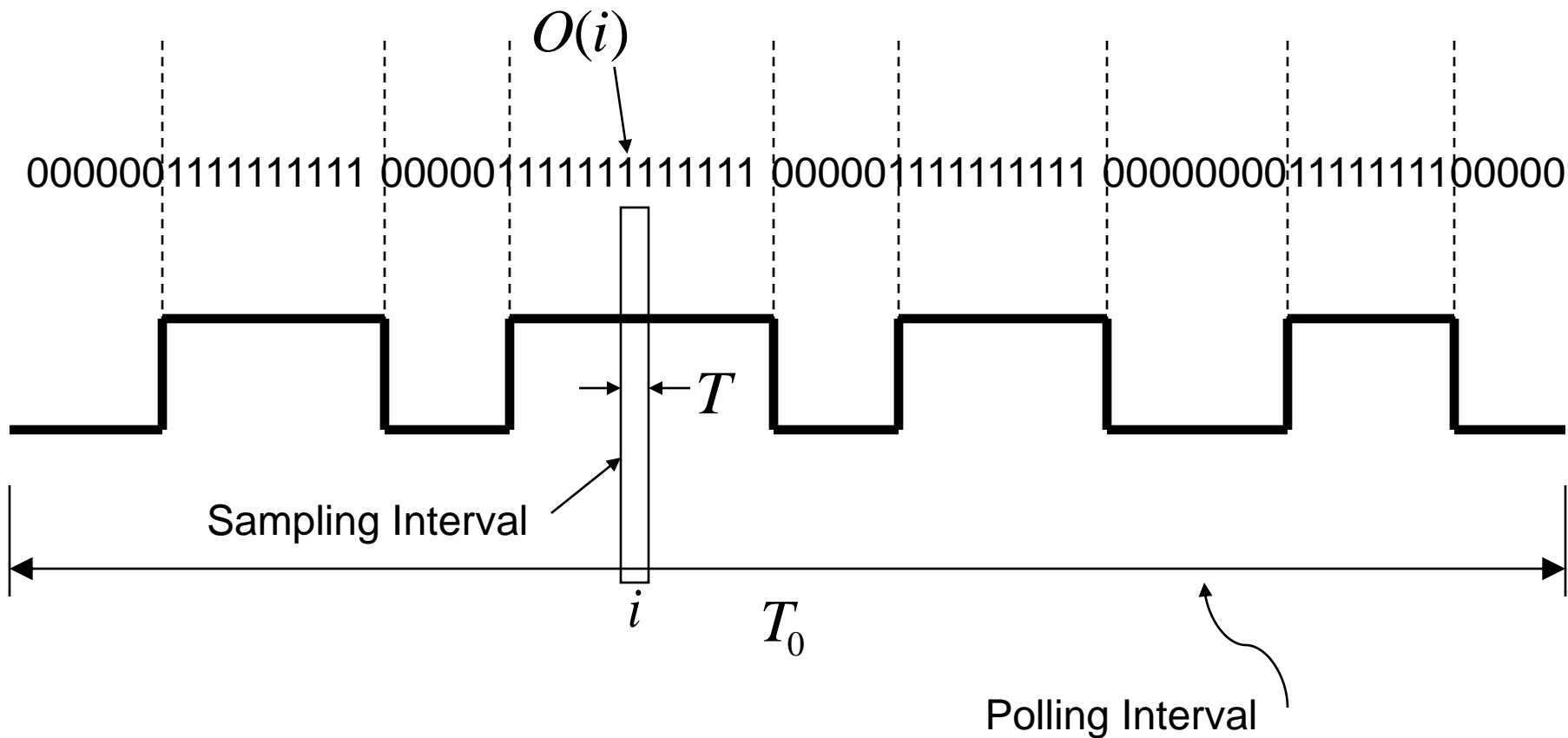

$$\text{Occupancy} = \frac{\sum_i O_i}{T_0} \cdot 100\%$$

Traffic Flow Relationships

$$q = \frac{N}{t} \text{ (vph)}$$

$$k = \frac{5280 \cdot \textit{Occupancy}}{(L + L_D)} \text{ (vpm)}$$

$$v = \frac{q}{k} \text{ (mph)}$$